

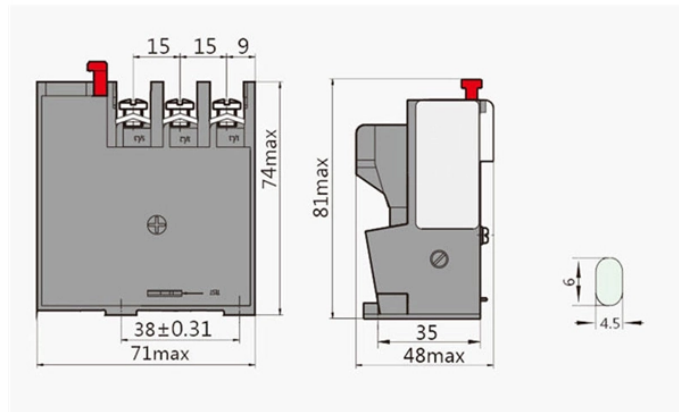

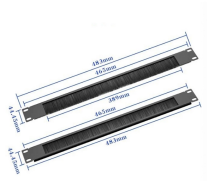

Which busbar is the relay protection bus



Which busbar is the relay protection bus

	<p>Due to its extensive I/O capability, REB670 protects single, double, and triple busbar. It can also handle all internal multi-phase faults in isolated or high-impedance earthed power systems.</p>
	<p>The GRB200 low impedance differential relay for busbar protection is designed to provide very reliable, high-speed and selective protection for various types of ...</p>
	<p>The GRB200 low impedance differential relay for busbar protection is designed to provide very reliable, high-speed and selective protection for various types of busbar system.</p>
	<p>Relays and busbars work together to ensure stability and efficient distribution of incoming and outgoing current in an electrical power system. A good bus bar protection system should detect ...</p>
	<p>2) A double busbar system uses two protection relays, one for each bus section, to isolate faults. When the bus coupler is closed, the relays see an imbalance but ...</p>

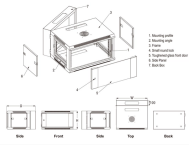

The distributed busbar protection consists of one Central Unit (CU) and a number of Bay Units (BU). The central unit links to bay units via optical fibers in point-to-point communication mode.



Sectionalized Busbar Protection: Different zones of a busbar have separate protection relays to isolate faults in specific sections, enhancing system stability.



Operation of the supervision relay is arranged to give an alarm that the busbar protection is faulty, and to short circuit the bus wires for this is necessary to prevent damage to the protective ...



The B90 Bus Differential Relay provides protection of multiple segment busbars, using a phase-segregated, centralized protection scheme. The B90 is phase-segregated to simplify the design of ...



This paper examines several common bus configurations, presents appropriate protection schemes for each configuration, and analyzes the protection scheme complexity, advantages, and disadvantages.



Low-Impedance Bus Differential Protection— Provide flexible low-impedance bus differential protection for various busbar topologies and sizes. You can protect systems with up to 21 three-phase bus ...



SIPROTEC 7SS85 busbar protection is a selective, safe and fast protection against busbar short circuits in a large variety of busbar configurations. The compact universal relay for medium-voltage grids. ...

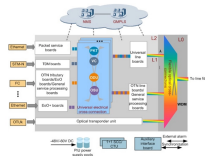

ABB's busbar protection is designed for phase-segregated short-circuit protection, control, and supervision of single busbars. The busbar protection relay is intended for use in high-impedance ...

Contact Us

For more information, pricing, or custom data center solutions, please contact us:

Website: <https://www.yoahorroenergia.es>

Email: hello@yoahorroenergia.es

Phone: +233 54 318 7269

Address: Plot 28, Spintex Road, Accra, Greater Accra, Ghana

This document is for informational purposes only. Specifications subject to change without notice.

